RT4803B 2.5MHz Synchronous Boost Regulator Evaluation Board

General Description

The RT4803B allows systems to take advantage of new battery chemistries that can supply significant energy when the battery voltage is lower than the required voltage for system power ICs. By combining built-in power transistors, synchronous rectification, and low supply current, this IC provides a compact solution for systems using advanced Li-Ion battery chemistries.

The RT4803B is a boost regulator designed to provide a minimum output voltage from a single-cell Li-Ion battery, even when the battery voltage is below the system minimum. In boost mode, output voltage regulation is guaranteed up to a maximum load current of 2000mA. The quiescent current in shutdown mode is less than 1 μ A, which maximizes battery life. The regulator transitions smoothly between bypass and normal boost modes. The device can be forced into bypass mode to reduce quiescent current.

Table of Contents

General Description	1
Performance Sepcification Summary	2
Power-up Procedure	2
Detailed Description of Hardware	4
Bill of Materials.....	6
Typical Applications	7
Evaluation Board Layout.....	10
More Information.....	12
Important Notice for Richtek Evaluation Board.....	12

Performance Specification Summary

Summary of the RT4803B Evaluation Board performance specification is provided in Table 1. The ambient temperature is 25°C.

Table 1. RT4803B Evaluation Board Performance Specification Summary

Specification	Test Conditions	Min	Typ	Max	Unit
Input Voltage Range		1.8	--	5	V
Output Voltage Range		2.85	--	4.4	V
Quiescent Current	Boost mode, I _{LOAD} = 0mA, switching, V _{IN} = 3V	--	56	100	μA
Shutdown Current		--	--	2	μA
Output Voltage Accuracy	V _{OUT} - V _{IN} > 100mV, PWM	-2	--	2	%
Boost Valley Current Limit	V _{IN} = 2.9V	3.5	4	4.5	A
Operation Frequency	V _{IN} = 2.65V, V _{OUT} = 3.5V, I _{LOAD} = 1000mA	--	2.5	--	MHz
SCL, SDA High-Level Input Threshold Voltage		0.84	--	--	V
SCL, SDA Low-Level Input Threshold Voltage		--	--	0.36	V

Power-up Procedure

Suggestion Required Equipments

- RT4803B Evaluation Board
- DC power supply capable
- Electronic load

Quick Start Procedures

The Evaluation Board is fully assembled and tested. Follow the steps below to verify board operation. Do not turn on supplies until all connections are made. When measuring the output voltage ripple, care must be taken to avoid a long ground lead on the oscilloscope probe. Measure the output voltage ripple by touching the probe tip and ground ring directly across the last output capacitor.

Proper measurement equipment setup and follow the procedure below.

- 1) With power off, connect the input power supply to the VIN and GND pins.
- 2) With power off, connect the electronic load between the VOUT and nearest GND pins.
- 3) When pulling the VSEL pin to L, the default output voltage setting is V_{OUT} = 3.15V. When pulling the VSEL pin to H, the default output voltage setting is V_{OUT} = 3.4V.
- 4) When pulling the nBYP and EN pins to H, the device operate in boost and auto bypass mode. The detailed mode is defined in Table 2.

- 5) Turn on the power supply at the input. Make sure that the input voltage does not exceeds 5V on the Evaluation Board.
- 6) Check for the proper output voltage using a voltmeter.
- 7) Once the proper output voltage is established, adjust the load within the operating ranges and observe the output voltage regulation, ripple voltage, efficiency and other performance.

Table 2

EN Input	nBYP Input	Mode Define	Device State
0	0	Forced bypass with low quiescent mode	The device operates in forced bypass with a low quiescent mode featuring a low quiescent current down to about 4 μ A (typical).
0	1	Shutdown mode	The device is in shutdown mode. The shutdown current is approximately about 1 μ A (maximum).
1	0	Forced bypass without low quiescent mode	The device is active in forced bypass mode without the low quiescent mode. The device supply current is approximately about 15 μ A (typical).
1	1	Boost and auto bypass mode	The device includes boost and auto bypass modes, depending on whether V_{IN} is larger than V_{OUT} . The device supply current is approximately about 35 μ A (typical) in auto bypass mode and 55 μ A (typical) in boost mode.

Detailed Description of Hardware

Headers Description and Placement

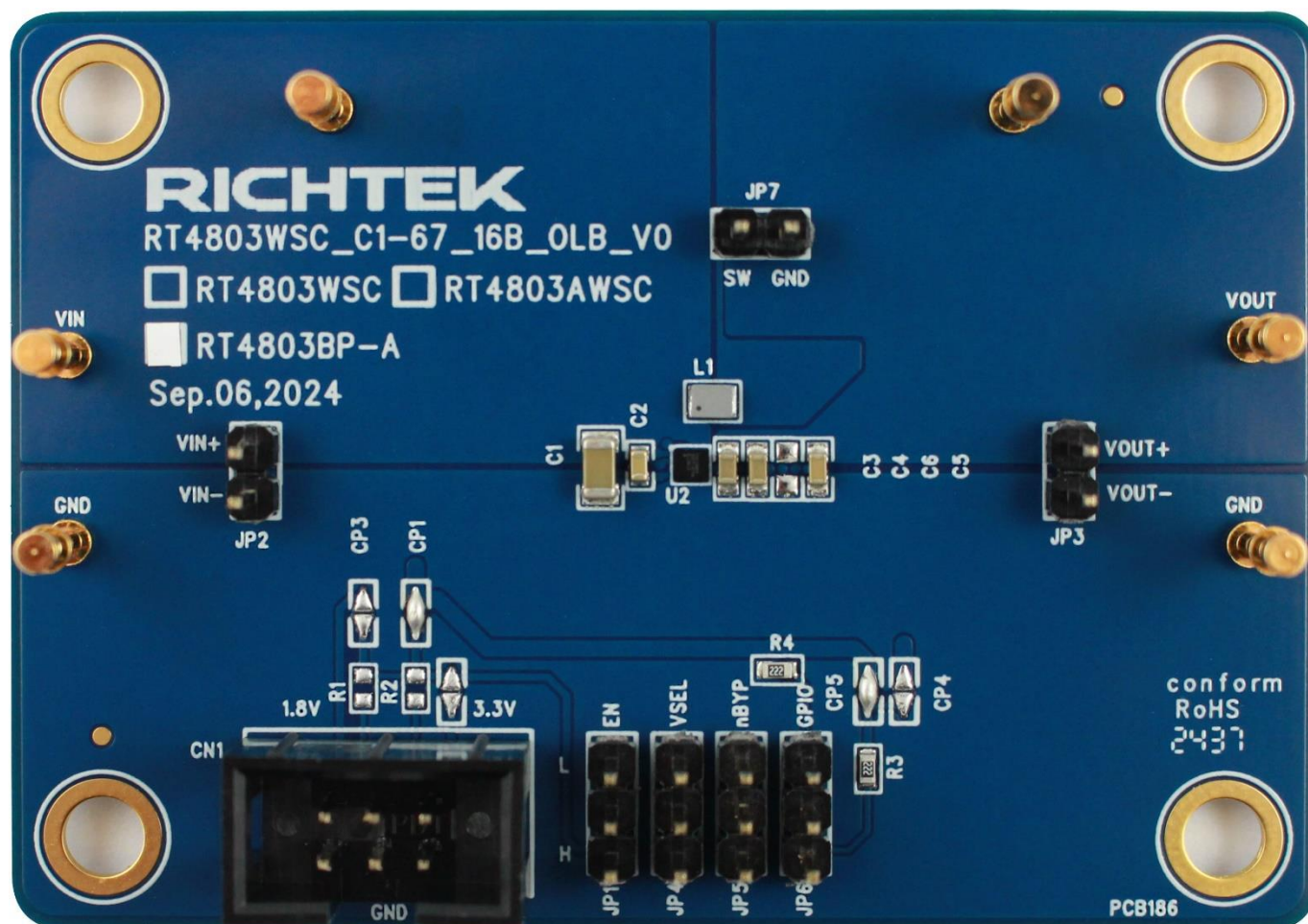

Carefully inspect all the components used in the EVB according to the following Bill of Materials table, and then make sure all the components are undamaged and correctly installed. If there is any missing or damaged component, which may occur during transportation, please contact our distributors or e-mail us at evb_service@richtek.com.

Test Points

The EVB is provided with the test points and pin names listed in the table below.

Test Point/ Pin Name	Function
VIN	Input voltage.
VOUT	Output voltage.
AGND	Analog ground. This is the signal ground reference for the IC.

Test Point/ Pin Name	Function
PGND	Power ground should be connected to this pin with the shortest path for power transmission to reduce the parasitic components effects.
EN	Enable test point.
GPIO	General purpose input/output.
VSEL	Output voltage selection pin. The default boost output voltage setting is $V_{OUT} = 3.4V$ at $V_{SEL} = H$ and $V_{OUT} = 3.15V$ at $V_{SEL} = L$. This pin must be terminated.
SW	Switch node test point.
nBYP	This pin can be used to activate forced bypass mode. When this pin is LOW, the bypass switches are turned on into forced bypass mode. The detailed mode is defined in Table.
SDA	Serial interface data line. (Pull down if I ² C is not used.)
SCL	Serial interface clock. (Pull down if I ² C is not used.)

Bill of Materials

Reference	Count	Part Number	Value	Description	Package	Manufacturer
U1	1	RT4803BP-A	--	Boost Converter	WL-CSP-16B 1.67x1.67 (BSC)	RICHTEK
C1	1	JMK316BJ476ML-T	47μF	Capacitor 6.3V, X5R	1206	TAIYO YUDEN
C2	1	GRM188R61A106KE69	10μF	Capacitor 10V, X5R	0603	Murata
C3, C4, C5	3	GRM188R61A226ME15D	22μF	Capacitor 10V, X5R	0603	Murata
L1	1	HTEK20161T-R47MSR	0.47μF	Inductor 5.5A, 18mΩ	2016	Cyntec
R3, R4	2	WR06X2201FTL	2.2k	Resistor	0603	WALSIN
CN1	1	CHEB254S006-CF1043	--	I ² C	15.24x9x8.8mm	CHERNG WEEI

Typical Applications

EVB Schematic Diagram

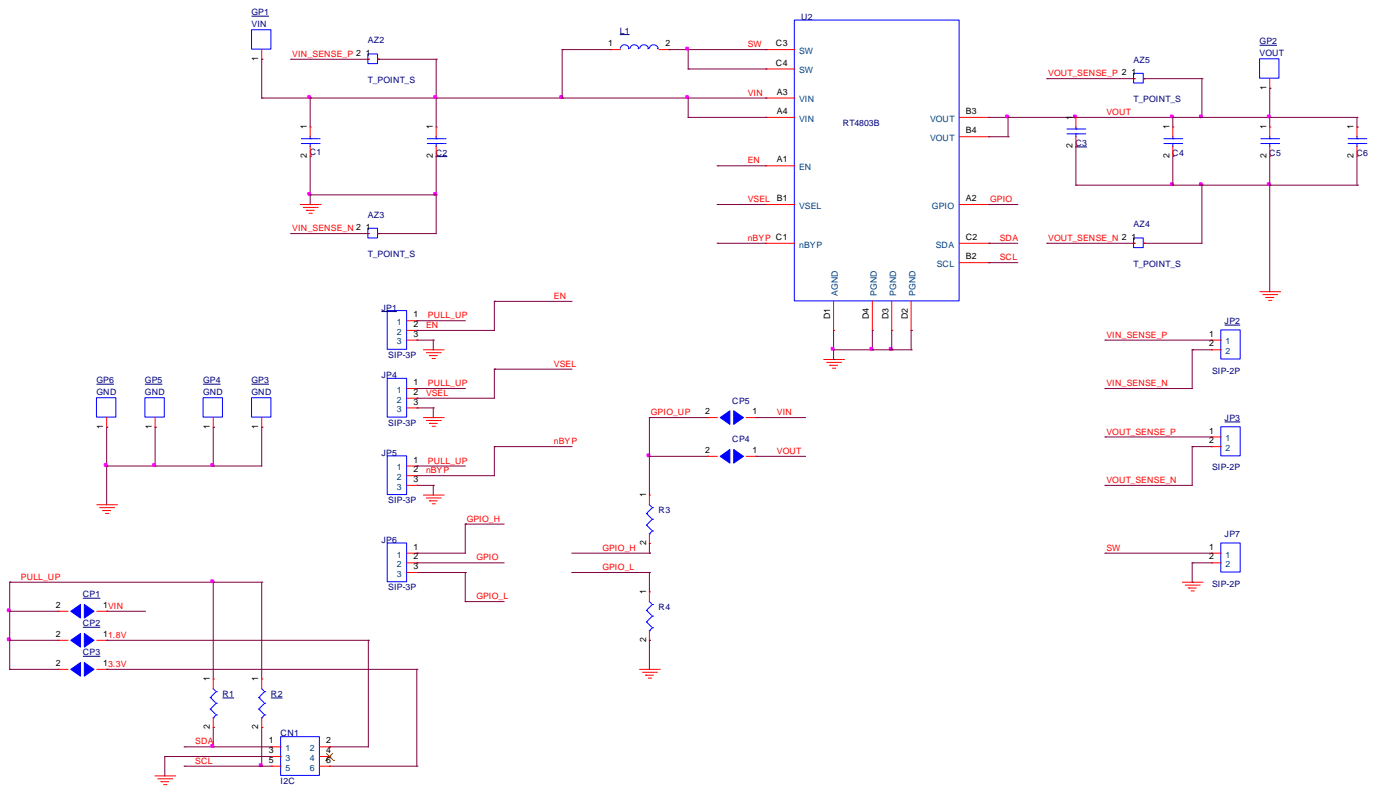

1. The capacitance values of the input and output capacitors will influence the input and output voltage ripple.
2. MLCC capacitors have degrading capacitance at DC bias voltage, and especially smaller size MLCC capacitors will have much lower capacitance.

Measure Result

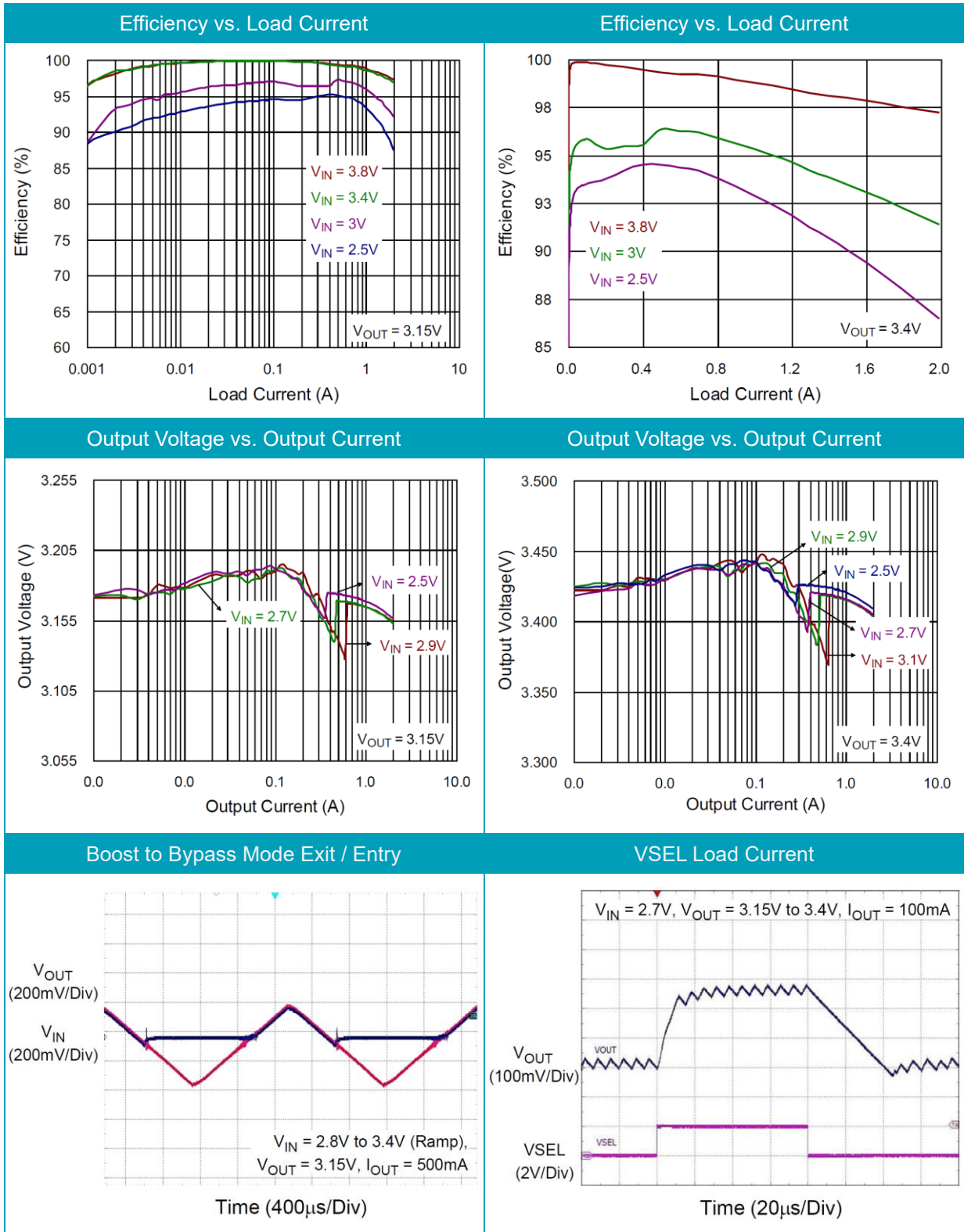

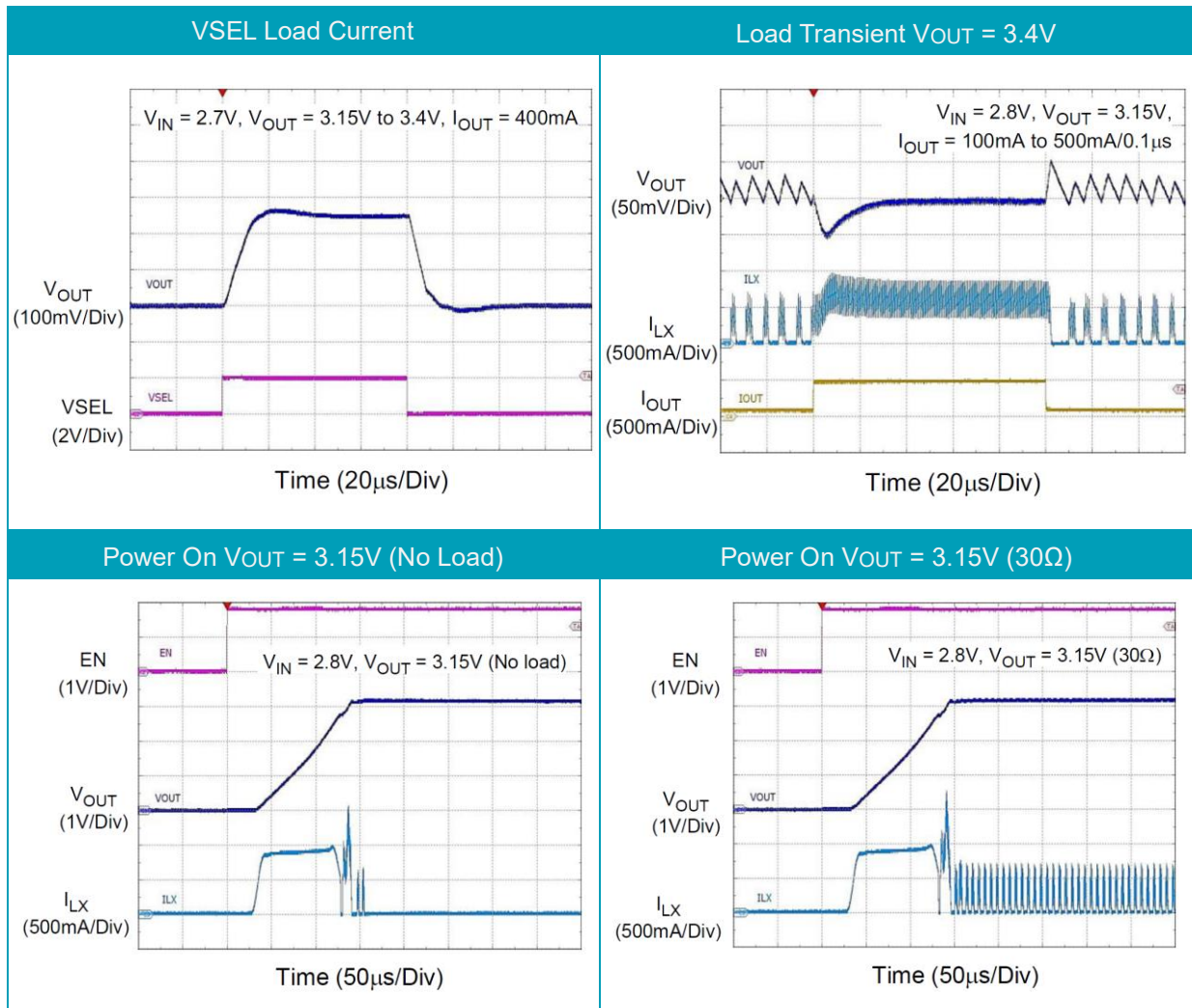

Note: When measuring the input or output voltage ripple, care must be taken to avoid a long ground lead on the oscilloscope probe. Measure the output voltage ripple by touching the probe tip directly across the output capacitor.

Evaluation Board Layout

Figure 1 to Figure 4 are RT4803B Evaluation Board layout.

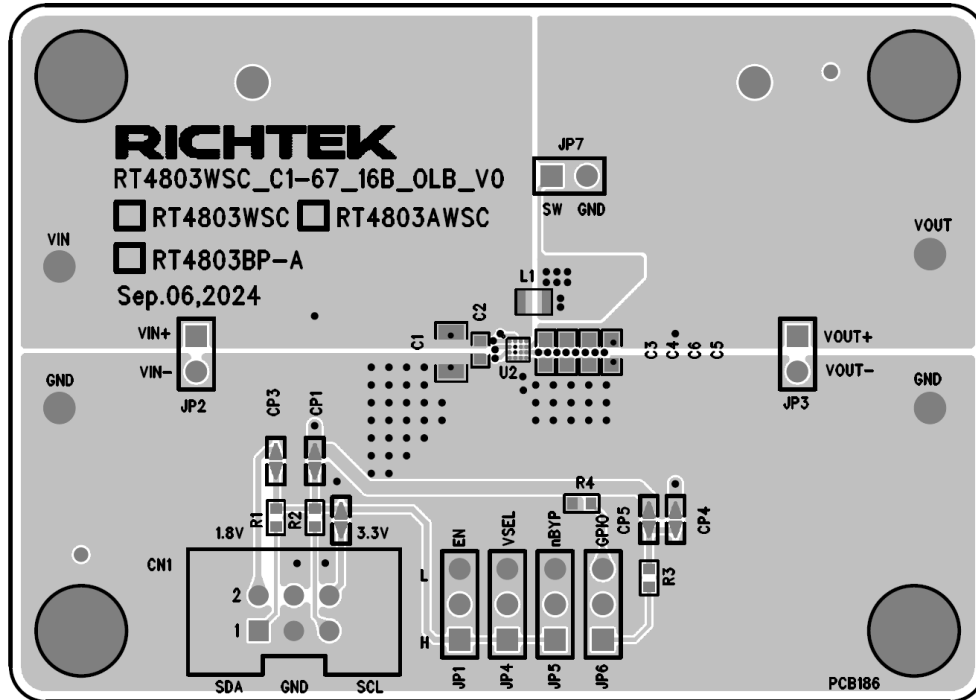

Figure 1. Top View (1st layer)

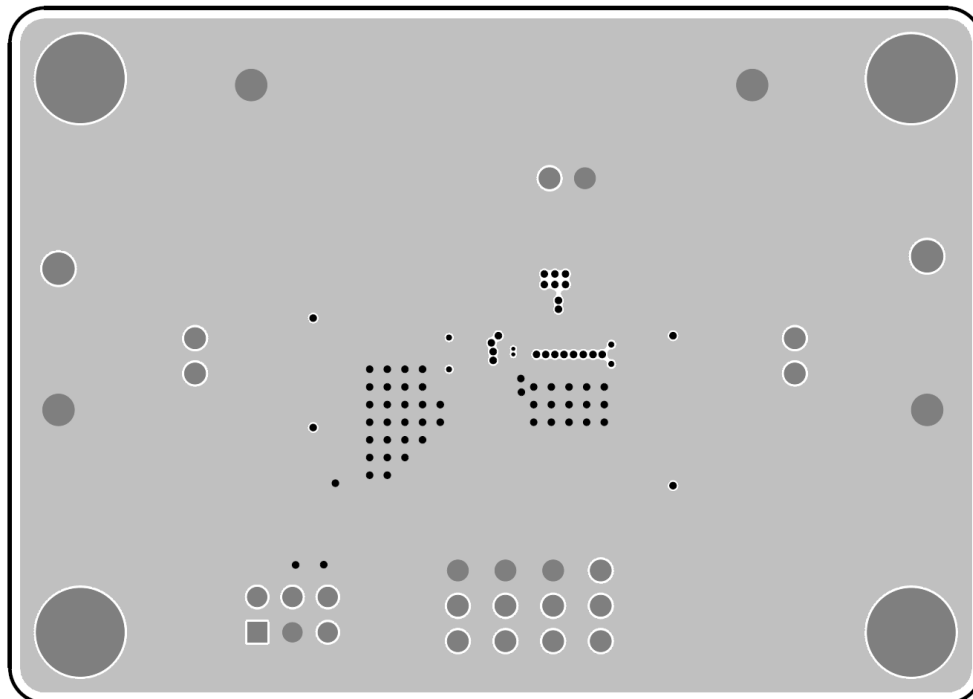

Figure 2. PCB Layout—Inner Side (2nd Layer)

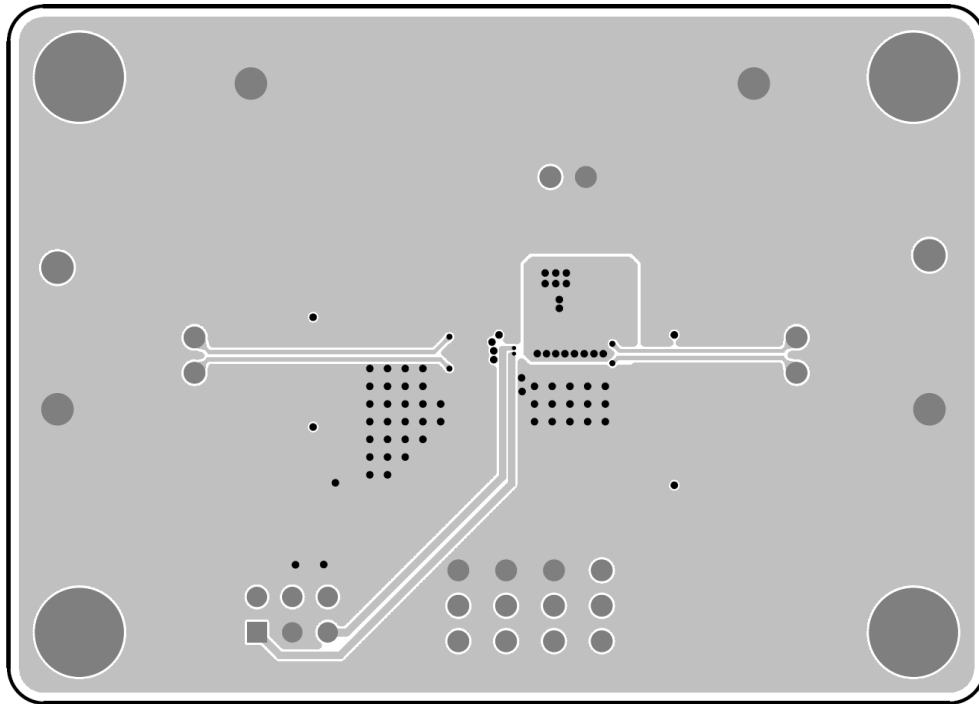

Figure 3. PCB Layout—Inner Side (3rd Layer)

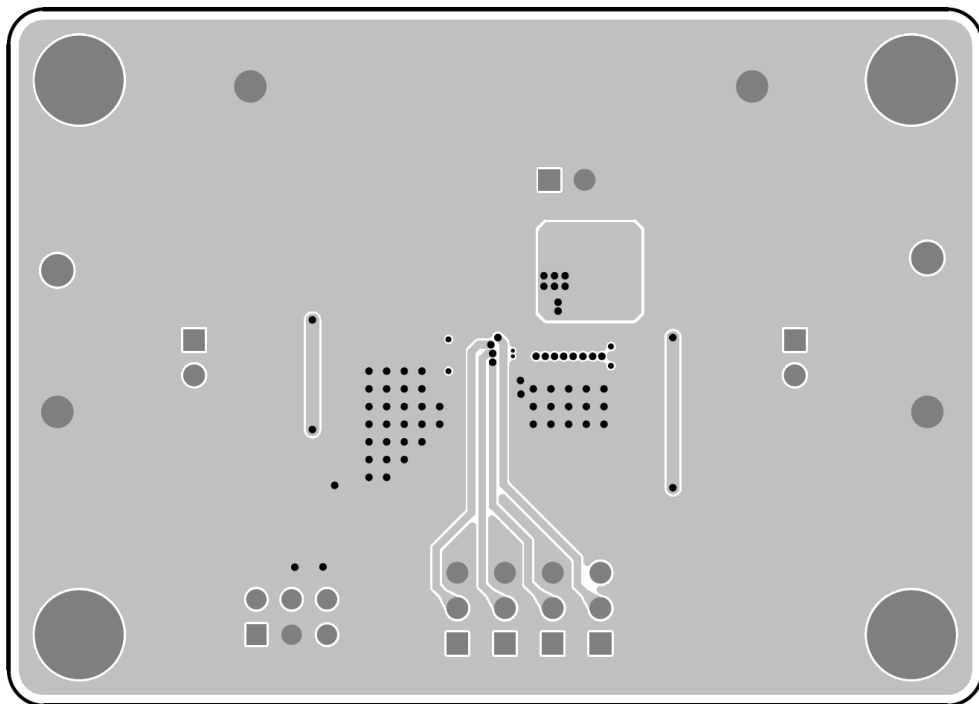

Figure 4. Bottom View (4th Layer)

More Information

For more information, please find the related datasheet or application notes from Richtek website
<http://www.richtek.com>.

Important Notice for Richtek Evaluation Board

THIS DOCUMENT IS FOR REFERENCE ONLY, NOTHING CONTAINED IN THIS DOCUMENT SHALL BE CONSTRUED AS RICHTEK'S WARRANTY, EXPRESS OR IMPLIED, UNDER CONTRACT, TORT OR STATUTORY, WITH RESPECT TO THE PRESENTATION HEREIN. IN NO EVENT SHALL RICHTEK BE LIABLE TO BUYER OR USER FOR ANY AND ALL DAMAGES INCLUDING WITHOUT LIMITATION TO DIRECT, INDIRECT, SPECIAL, PUNITIVE OR CONSEQUENTIAL DAMAGES.